

# **KitchenAid<sup>®</sup>**

*Trash Compactor*

**Model KUCS181T**

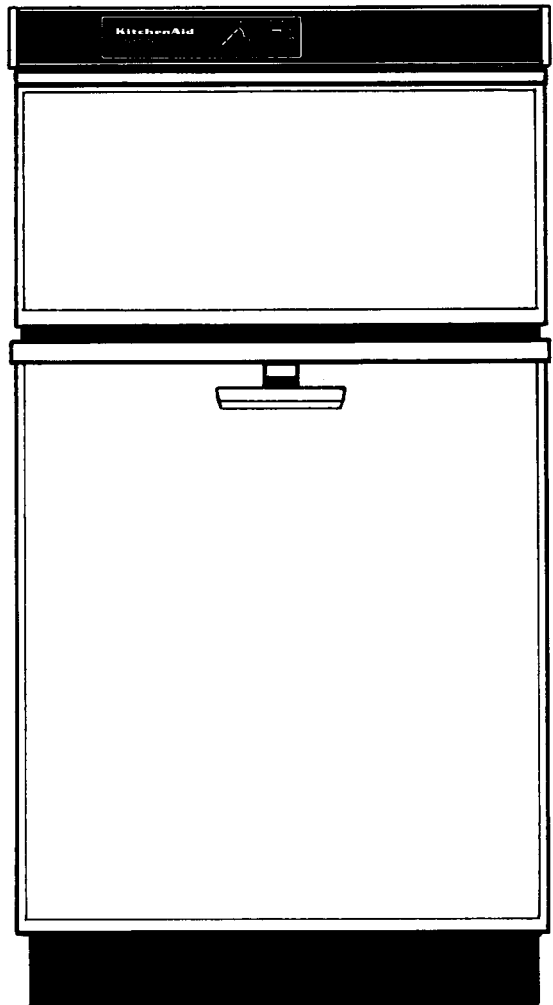

**USE and CARE GUIDE**

12-92

# Table of Contents

Important Safety Instructions . . . . .	3
Ownership Registration Card . . . . .	4
Compactor Features. . . . .	5
Preparing Your Compactor For Use . . . . .	6
Grounding Instructions . . . . .	6
Loading Your Compactor . . . . .	7
Use of Tilt-Away Trash Basket Without Bags . . . . .	8
Use of Tilt-Away Trash Basket With Bags . . . . .	9-10
Operating Your Trash Compactor . . . . .	11
Charcoal Air Filter With Fan . . . . .	12
Special Use Tips . . . . .	13
Caring For Your Compactor . . . . .	14-15
Changing Front Panels . . . . .	16-17
Availability of Accessories . . . . .	17
Use Energy Wisely. . . . .	17
If You Need Service Or Assistance. . . . .	18
Warranty . . . . .	Back Cover

# Important Safety Instructions

To reduce the risk of fire, electrical shock, injury to persons, or damage when using your compactor, follow basic precautions, including the following:

1. Read all instructions before using the compactor.
2. The compactor is for household use only.
3. **Always** use compactor only as described in this manual.
4. **Do not** allow to be used as a toy, or to run unattended at any time. Close supervision is necessary when used by or near children. Lock key switch when not in use and store key out of reach of children.
5. **Do not** operate with a damaged cord, plug, motor, or after compactor has been damaged in any manner. Have the compactor examined, repaired, or adjusted by an authorized serviceman.
6. **Do not** take apart compactor. Incorrect reassembly can cause electrical shock when next used.
7. **Do not** touch moving parts.
8. **Do not** overload compactor. **Do not** overload trash with heavy material such as glass.
9. **Always** place glass bottles, etc. on their sides in the center of the drawer so the wastepaper below and beside the bottle can help keep broken glass near the center of the bag, away from the sides.
10. **Do not** compact any container or material which might contain poisonous or explosive products.
11. **Do not** compact cloths or cans containing paint liquids, thinners, etc. which could create a fire hazard.
12. **Do not** shove items down into the compactor with hands or feet. To avoid being cut, let the compactor do the compacting.
13. **Do not** lift a trash bag by the sides. Sharp objects can pierce the bag and cause injury. Always carry a filled trash bag by the top.
14. **Always** wipe off any broken glass before touching the ram cover.
15. **Do not** use the compactor as a counter for electrical cooking appliances nor as a cutting board.
16. **Do not** set hot pans, etc., on the compactor top.
17. **Do not** compact toxic or volatile flammable material such as oily rags and insect sprays. **Do not** compact lighted cigarettes, cigars or other hot or burning items.
18. **Do not** spill any liquids on the compactor top.
19. **Do not** use other than manufacturer's recommended attachments.

## FOR YOUR SAFETY

**DO NOT STORE OR USE GASOLINE OR OTHER FLAMMABLE VAPORS AND LIQUIDS IN THE VICINITY OF THIS OR ANY OTHER APPLIANCE. THE FUMES CAN CREATE A FIRE HAZARD OR EXPLOSION.**

**SAVE THESE INSTRUCTIONS**

# Ownership Registration Card

Before you use your compactor, please fill out and mail your ownership registration card packed with the Use and Care Guide. This card will enable us to contact you in the unlikely event of a product safety notification and assist us in complying with the provisions of the Consumer Product Safety Act. THIS CARD DOES NOT VERIFY YOUR WARRANTY.

Keep a copy of the bill of sale showing the date of purchase and /or date of installation of your compactor. PROOF OF PURCHASE WILL INSURE YOU OF IN-WARRANTY SERVICE.

Write down the following information. You will need it if your compactor ever requires service.

**Model Number\*** \_\_\_\_\_

**Serial Number\*** \_\_\_\_\_

**Date Purchased** \_\_\_\_\_

**Date Installed** \_\_\_\_\_

**Dealer's Name** \_\_\_\_\_

**Address** \_\_\_\_\_

**Phone** \_\_\_\_\_

\*Model and Serial Numbers are located on a label at the left side of the Trash Drawer opening on the Compactor frame.

# Compactor Features

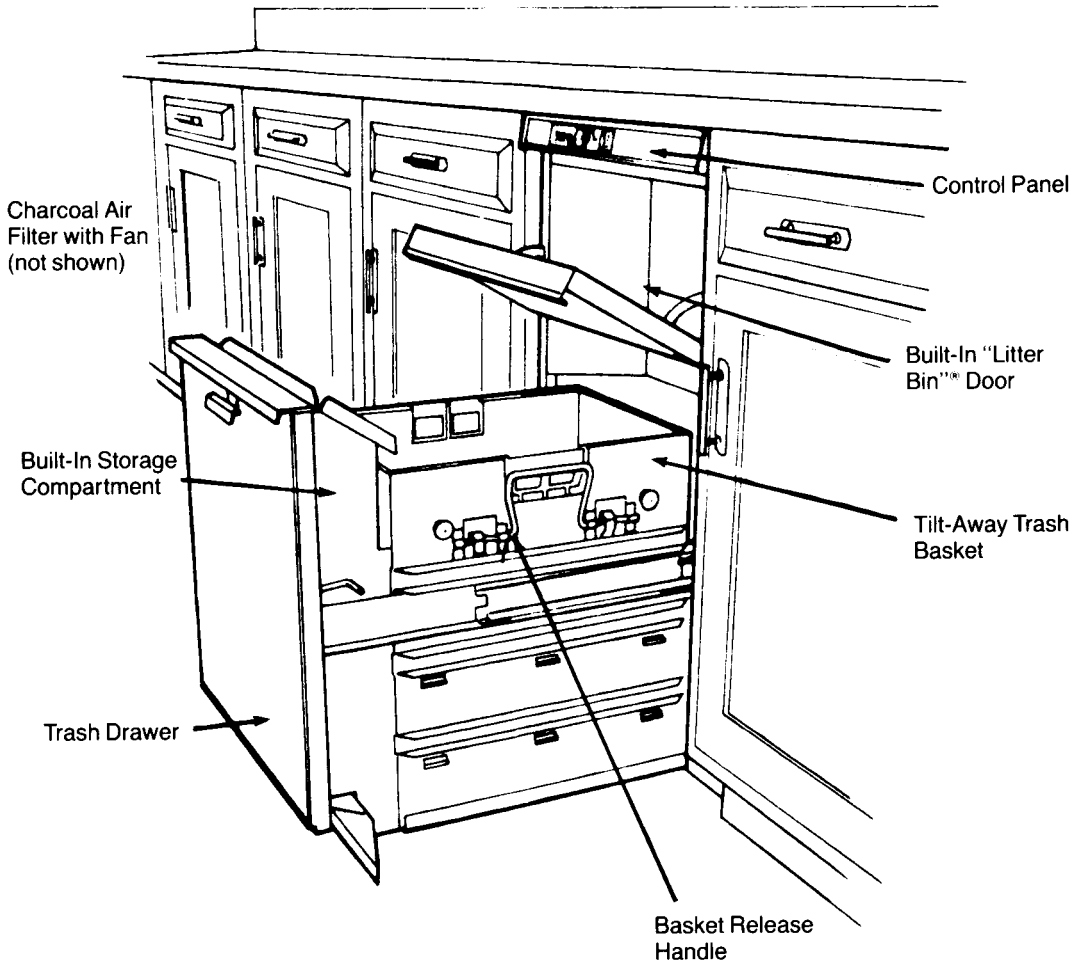

Your KitchenAid Compactor has a built-in interlock and will not operate unless you have:

1. Closed the Trash Drawer
2. Turned key to START

STOP/LOCK will stop the ram movement at any point. After stopping the unit, turn key to START and ram will return to original "up" position.

**Do not allow children to operate compactor. We recommend that you remove the key when not in use. The unit will not operate without it. The trash door cannot be locked. Therefore, before running a compaction cycle, always check to be sure that no item has been mistakenly placed in the Trash Drawer.**

# Preparing Your Compactor For Use

## Connecting Power Cord to Grounded Outlet

Your KitchenAid Compactor operates on regular 115 volts, 60 hertz a.c. house current to be supplied by a 3-PRONG GROUNDING RECEPTACLE LISTED BY UNDERWRITERS LABORATORIES. The circuit used should be protected by a 15-amp fuse or circuit breaker. Be sure key is in STOP/LOCK position before connecting Compactor to electricity.

Polarized 3-Prong Grounding Type Outlet

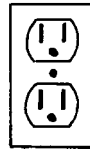

(A)

2-Prong Type Outlet



(B)

METAL SCREW

COVER OF GROUNDED

OUTLET BOX

Tab for Grounding Screw

Grounded Outlet Box



A temporary adapter that looks like the adapter shown above may be used to connect this plug to a 2-pronged outlet if a properly grounded outlet is not available. The green colored rigid ear, lug, and the like must be connected to a permanent ground such as a properly grounded outlet box. The temporary adapter should only be used until a properly grounded outlet can be installed.

### Electrical Shock Hazard

**Improper connection of the polarized 3-prong grounding type outlet can result in a risk of electric shock. Check with a qualified electrician or service person if you are in doubt as to whether the outlet is properly grounded. Do not modify the plug provided with the compactor. If it will not fit the outlet, have a proper outlet installed by a qualified electrician.**

## Grounding Instructions

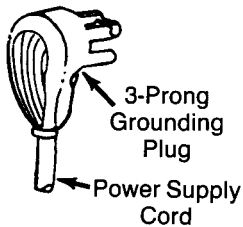

The compactor is for use on 115-volt, 60 Hz. AC only 15 ampere fused and properly grounded circuit and is equipped with a grounding plug as shown above. For your personal safety, the compactor must be grounded. In the event of an electrical short circuit, grounding reduces the risk of electric shock by providing an escape wire for the electric current. This appliance is equipped with a polarized 3-prong grounding plug. It must be plugged into a correctly polarized mating 3-prong grounding type outlet, properly installed and grounded in accordance with the national Electrical Code and local codes and ordinances.

**Do not use an extension cord.**

In recessed applications, do not pinch 3-prong plug between Compactor and wall. See your INSTALLATION INSTRUCTIONS for complete details.

## Leveling Compactor

Your Compactor has four leveling feet that will vary the height and provide level stability within a range of 1 1/4-inches. Simply raise or lower as required for your particular installation situation.

A minimum 1/4-inch clearance **MUST BE MAINTAINED** between Compactor top and counter top for service accessibility.

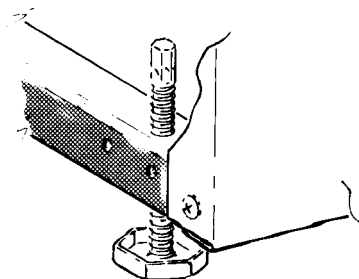

# Loading Your Compactor

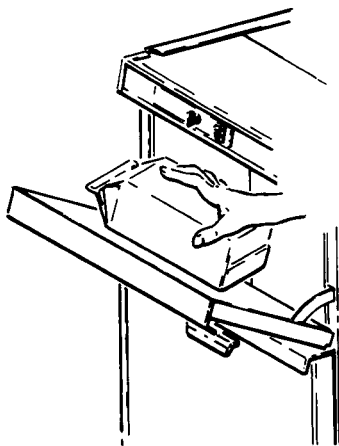

## **Built-In Litter Bin® Door**

Small cans, paper scraps, small boxes and containers may simply be dropped into the Bin, rather than opening the large Trash Drawer. Trash will drop automatically into the large Trash Drawer when pulled open.

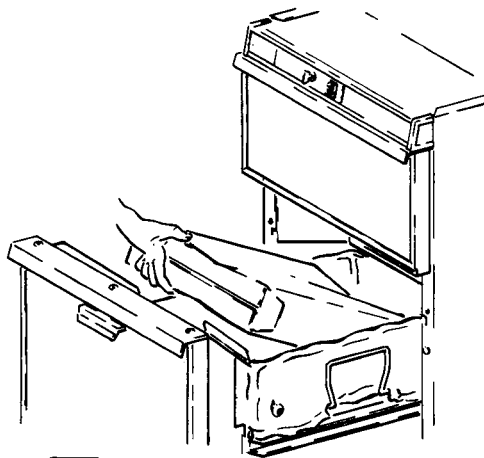

## **Large Capacity Trash Drawer**

Large, bulky items should be placed directly into the drawer. It isn't necessary to run a compaction cycle everytime you place trash into the drawer. However, the more often you run a cycle, the more compact the trash will be.

## **Tilt-Away Trash Basket**

Your KitchenAid Trash Compactor is equipped with a versatile two-piece, polypropylene basket. It is designed especially for easy use and removal of compacted trash. The Tilt-Away Basket may be used with or without the enclosed complimentary supply of trash bags.

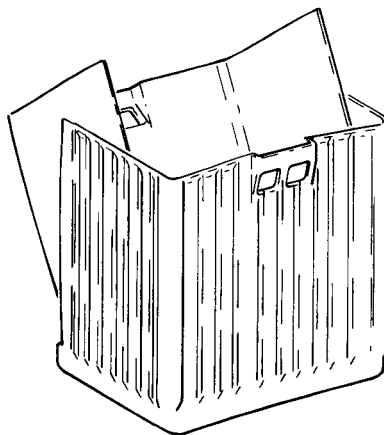

# Use of Tilt-Away Trash Basket Without Bags

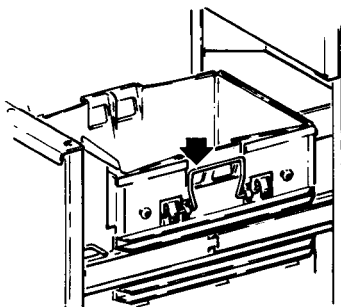

1. Place Basket Release Handle in upright position.
2. Put trash directly into the basket. We recommend placing several thicknesses of newspaper at the bottom of the basket when bags are not used. This will minimize clean-up of the basket after emptying compacted trash.

**Note:** Compacting a folded newspaper on top of loose trash will help keep the ram clean of trash or broken glass.

## To Remove Tilt-Away Trash Basket:

We recommend removing the basket when trash is compacted to four or five inches below the top of basket. If you find this too heavy, compact less trash next time. **REMEMBER** — the weight of the compacted trash will vary with the contents. Cans and bottles may weigh more than paper products.

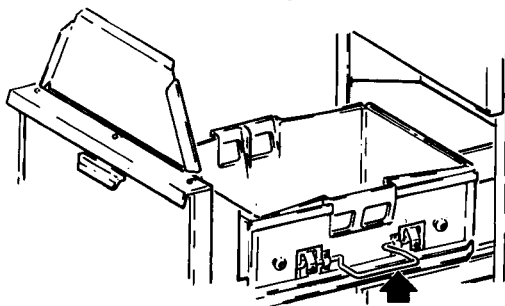

1. Place Basket Release Handle in down position. Lift Built-In Storage Compartment Cover up.

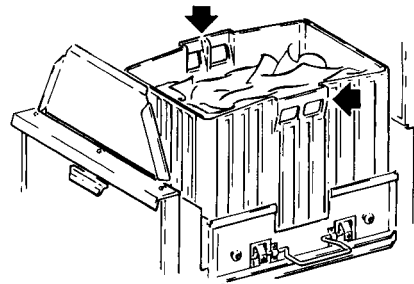

2. Grasp both handles of basket and remove from drawer. Carry basket to trash storage area.

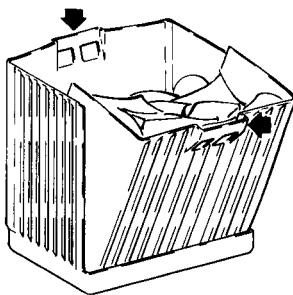

3. Pull handles of basket away from each other.



4. Dump compacted trash from half basket into waste receptacle.

### Personal Injury Hazard

**Compacted trash may contain broken glass, metal cans and other sharp objects. Always use the half basket to dump trash. DO NOT USE BARE HANDS.**



# Use of Tilt-Away Trash Basket With Bags

**Important:** Tilt-Away Trash Basket should always be in drawer when using compactor bags.

**Note:** Compacting a folded newspaper on top of loose trash will help keep ram clean of trash or broken glass.

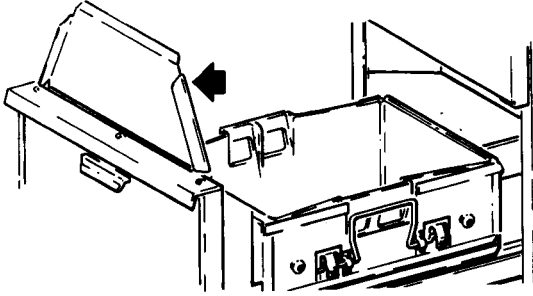

1. Lift Built-In Storage Compartment Cover.

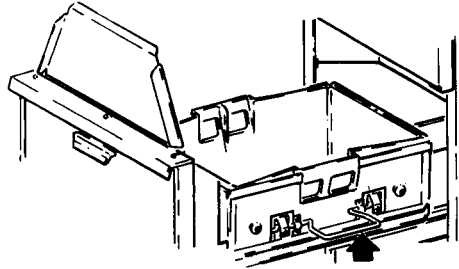

2. Pull Basket Release Handle down.

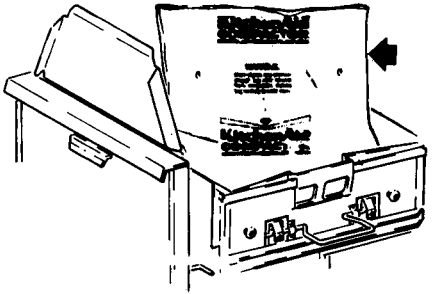

3. Place folded bag inside Tilt-Away Trash Basket.

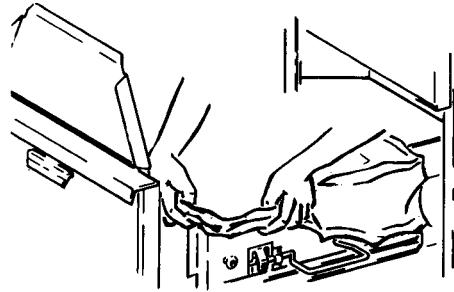

4. Open bag. Pull top edges of bag over top of drawer.

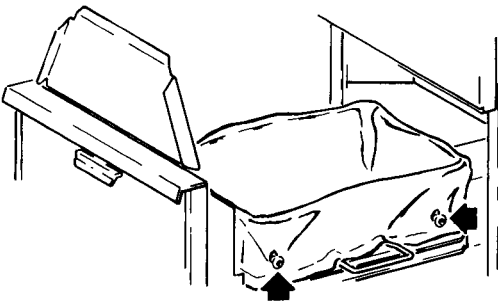

5. Lock bag in place by pulling four pre-punched holes over buttons on drawer sides. Holes will expand over buttons without damaging bag.

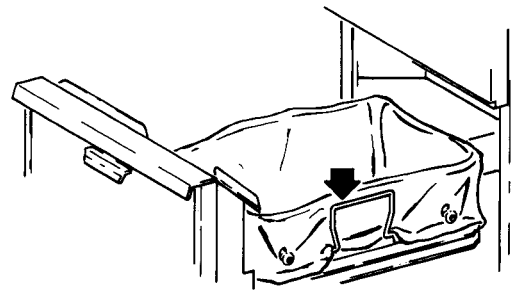

6. Spread bag to fit interior of basket. Close Storage Compartment Cover. Pull Basket Release Handle up.

## Bag Removal

We recommend removing bag when trash is compacted to four or five inches below top of basket. If you find this too heavy, compact less trash next time.

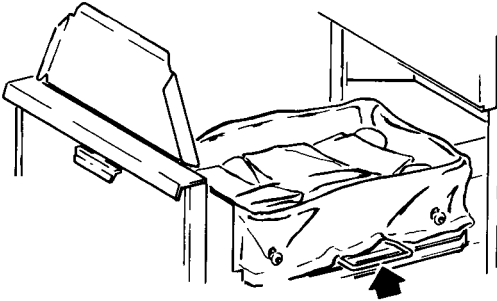

1. Pull Basket Release Handle down.

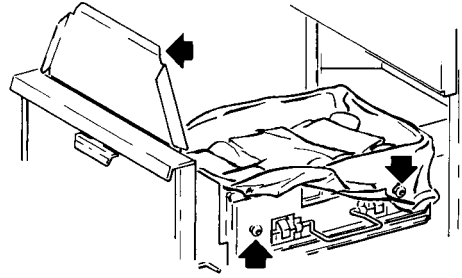

2. Lift Storage Compartment Cover up. Release bag from buttons. Pull up top edges of bag.

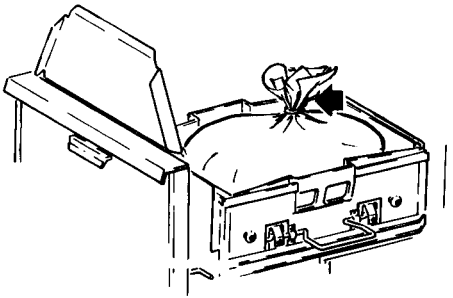

3. Close bag with twisties provided.

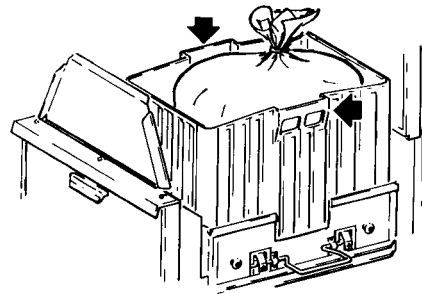

4. Grasp handles and remove from drawer. Carry basket with bag to trash storage area.

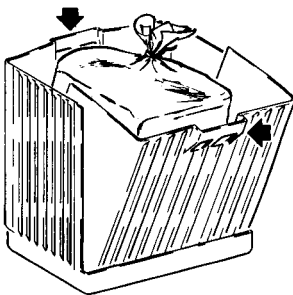

5. Pull handles of basket away from each other to loosen bag.

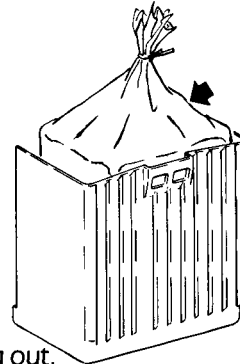

6. Lift bag out.

### Personal Injury Hazard

Sharp objects may protrude through bag after removal from trash basket. Handle carefully by the top to avoid injury.

# Operating Your Trash Compactor

## To Start:

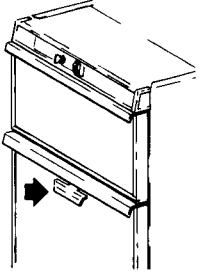

1. Close large Trash Drawer.

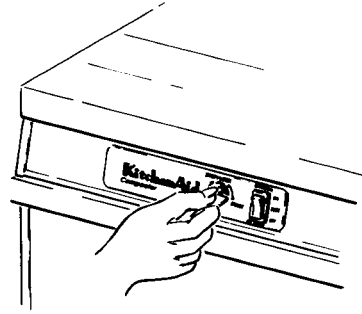

2. Turn key to START position and HOLD MOMENTARILY. Release key.

## The Compaction Cycle

The Compactor ram will move down inside the trash drawer, reverse and return to original position, completing the cycle in approximately 35 seconds. As the basket is filled, the ram travels a shorter distance and cycle time decreases.

DURING THE COMPACTION CYCLE, THE RAM DOES NOT TOUCH THE BOTTOM OF THE DRAWER. THEREFORE, YOU CAN EXPECT TO CYCLE SEVERAL LOOSE TRASH LOADS BEFORE COMPACTION IS EVIDENT. THIS IS NORMAL AND NOT A CAUSE FOR CONCERN.

As the ram compacts difficult to break items, you may notice a downward movement of the Compactor drawer. This is normal and will not cause damage. The spring-loaded drawer is specially designed to move down freely and return to original position. The force of the ram during a compaction cycle is absorbed by the Rigidized Steel Frame of the Compactor.

## To Stop Cycle and Open Drawer:

You may stop or interrupt a compaction cycle at any time and raise the ram to its original position.

1. Turn the key to STOP/LOCK position to stop the ram.
2. Then turn the key to START position and HOLD MOMENTARILY to return the ram to original position. The drawer may then be opened.
3. Turn key to START position and HOLD MOMENTARILY to start another compaction cycle.

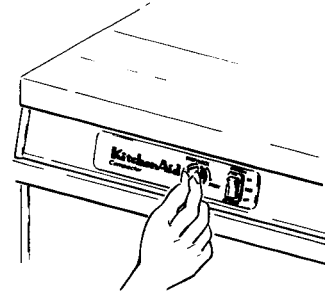

# Charcoal Air Filter With Fan

Your KitchenAid Trash Compactor features an Activated Charcoal Air Filter and Fan which absorbs and minimizes odor. The Charcoal Filter is located in the left rear section of the Compactor.

The degree of odor in your Compactor will depend upon the type trash you place in it. Since odors are absorbed into the pores of the Charcoal Filter, it may need to be replaced once or twice a year. Length of time before filter replacement is necessary varies with the types of trash compacted.

WE RECOMMEND USE OF A KITCHENAID FOOD WASTE DISPOSER FOR GARBAGE.

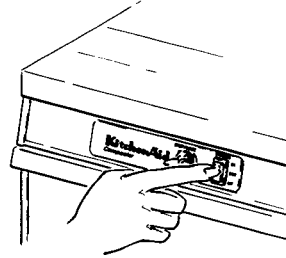
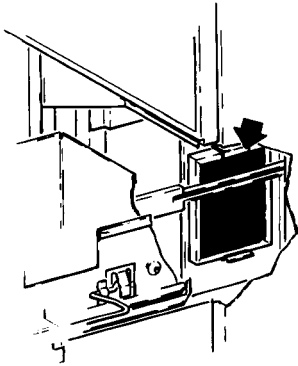

## Charcoal Air Filter Fan

ON — The fan creates fast air movement for greater odor removal.

OFF — Even when the fan isn't running, the filter is working to remove odor.

## To Remove Filter:

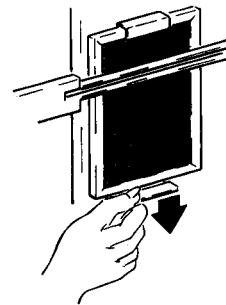
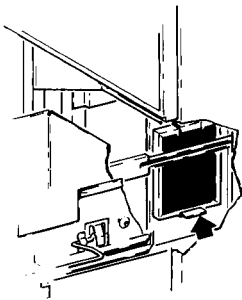

1. With Trash Drawer in open position, reach into left rear corner where filter is located.

2. Release filter from bottom clip and pull down.

## To Replace Filter:

Push replacement filter into place behind top clip. Snap securely into bottom clip.

# Special Use Tips

- Your KitchenAid Compactor is designed to handle most dry trash. THE COMPACTOR IS NOT A SUBSTITUTE FOR A FOOD WASTE DISPOSER. We urge you to continue to dispose of garbage through a KitchenAid Food Waste Disposer. Most food waste will sour and become odorous when held at room temperature.
- Liquid or messy items should be wrapped in a newspaper or several thicknesses of paper toweling to help keep the Ram and Tilt-Away Trash Basket clean.
- Place glass bottles on their sides in the center for compacting rather than upright. Bottles and cans may nest in lightly compacted paper. When a sufficient load is accumulated, most will be crushed. However, due to the resiliency of paper, some bottles may not break.

Don't be alarmed by the popping noise made when bottles are crushed. This is normal and will not damage the Compactor. Placing a newspaper over bottles before compacting will help muffle noise.

- More trash can be compacted if you stop the Ram in the "down" position and allow it to dwell there overnight. This will result in heavier bags of compacted trash.

## We Do Not Recommend Compacting These Items:

- Trimmings from cleaning fish or chicken
- Grapefruit or cantaloupe rinds
- Paint, oil, gasoline or turpentine cans or rags which have been used with these materials
- Aerosol cans
- Insecticide, toxic or caustic chemical containers
- Wood scraps, rocks, solid metal or large quantities of newspaper. These items are already in their compact form.

### Fire/Health Hazards

**Do not compact containers of flammable or toxic materials or aerosol cans.**

## Vacation Care

- If you are planning a weekend vacation, you may not want to remove compacted trash if basket is only partially full. We recommend you simply lock the Compactor. On your return, you may wish to run the Charcoal Air Filter Fan for a short time before opening the drawer.
- If you are planning to be away for more than a weekend, we recommend that you remove and discard the compacted trash. Replace basket and lock the Compactor. Before running a compaction cycle, ALWAYS check that no item has been mistakenly placed in the Trash Drawer.

# Caring For Your Compactor

## COMPACTOR INTERIOR

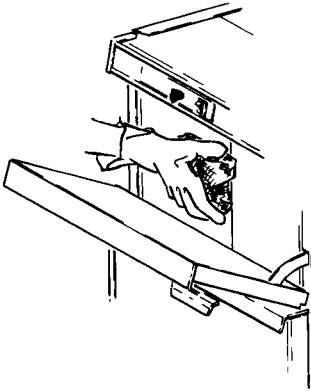

### **Built-In Litter® Door and Area:**

Wipe clean with a cloth or sponge and a mild detergent or ammonia and water. Rinse with clear water and dry. Do not use abrasive or harsh cleansers.

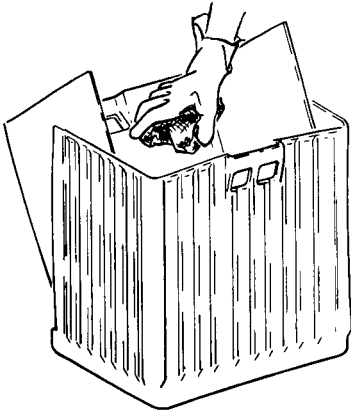

### **Tilt-Away Trash Basket:**

Clean as necessary after emptying compacted trash. Wearing rubber gloves and using paper toweling, remove any small pieces of debris from basket such as paper or crushed glass. **AVOID CONTACT WITH BARE HANDS.** Light soil may be wiped away with a damp sponge or cloth. Heavy soil may require use of mild detergent and water. Rinse with clear water and dry.

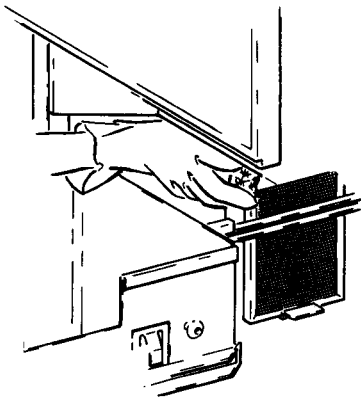

### **Ram:**

Clean as necessary. Wearing rubber gloves and using paper toweling, remove any small pieces of debris from ram, such as paper or crushed glass. **AVOID CONTACT WITH BARE HANDS.** Light soil may be wiped clean with a cloth and mild detergent and water. Heavy soil may require the use of a dampened scouring pad. Rinse with clear water and dry.

### **Metal Drawer Liner:**

Clean as necessary using a cloth or sponge and a mild detergent and water. Rinse with clear water and dry. Do not use abrasive cleansers.

### **Metal Drawer:**

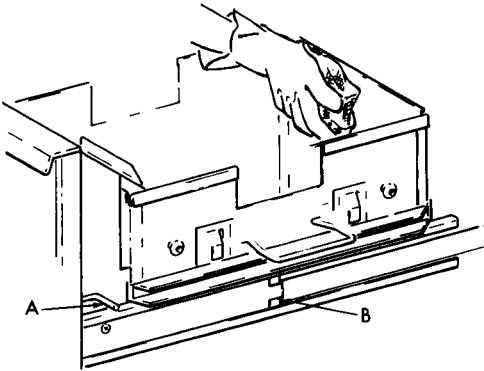

Occasionally, the drawer latch rod (A), and slide hook (B) located on both sides of the drawer opening should be lubricated. This will prevent the door latch from squeaking or sticking and help insure and extend the life of the latch mechanism. We suggest soap or a solid stick lubricant which can be purchased at auto supply or hardware stores.

### **Behind Metal Drawer:**

Occasionally check the area behind the Trash Drawer and remove any small pieces of trash. Placing a folded newspaper on top of trash will help prevent small items from sticking to the ram and falling behind the drawer.

**Note:** Drawer may be removed to facilitate cleaning surrounding areas.

1. **Disconnect power supply to compactor before removing drawer for cleaning.**
2. Be sure ram is in "up" position.

3. Open drawer to fully extended position.
4. Remove drawer retaining screws which hold drawer to track assembly. Carefully remove drawer from track assembly, making sure that the full weight of the drawer is supported at all times.

## **COMPACTOR EXTERIOR**

### **Front Panels:**

Wipe clean with a cloth or sponge and mild detergent and water. Rinse with clear water and wipe dry. Do not use abrasive cleansers.

### **Maple Wood Top:**

The maple wood top is prefinished with a protective lacquer seal. For daily care, wipe with a damp cloth. To remove stubborn stains, cover stain with dampened scouring powder for three to five hours. Then wipe away with a damp cloth.

After an extended period of use, it may be necessary to recondition the top by lightly sanding off all remaining lacquer and applying mineral oil to the cutting board. Saturate a clean cloth with oil and wipe on. Allow to absorb overnight. Repeat oil treatment the following day and allow to stand four to six hours before removing excess oil with soft, dry cloth. The top is then ready to use. Repeat treatment every six to eight months, as necessary.

# Changing Front Panels

Your Compactor comes equipped with two reversible front panels painted Almond/White and Harvest Wheat/Onyx Black, providing four front panel colors from which to choose.

Additional Compactor Front Panels are available in Fresh Avocado/Coffee or Stainless Steel from your KitchenAid dealer.

If you want to change the color of the panels, follow these steps:

## Electrical Shock Hazard

**Disconnect electrical power supply to compactor before changing panels. Failure to do so could result in electrical shock or personal injury.**

### Litter Bin® Door Panels:

1. **Disconnect power supply to compactor before changing panel.**
2. Open Litter Bin Door and remove three retaining screws in door handle; remove handle.
3. Slide panel out. **HANDLE CAREFULLY SO THE PANELS WILL NOT BE SCRATCHED OR BENT.** Replace panel so the desired color is exposed.
4. Replace the handle and screws.

### Drawer Panels — Recessed Unit:

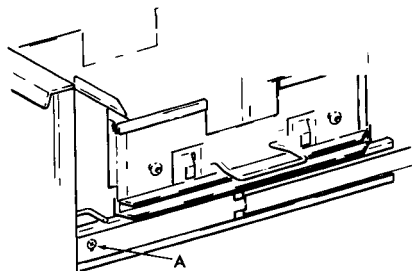

1. **Disconnect power supply to compactor before changing panel.**
2. Be sure ram is in "up" position.
3. Open drawer to fully extended position.
4. Remove drawer retaining screws (A) which hold drawer to track assembly. Carefully remove drawer from track assembly, making sure that full weight of drawer is supported at all times.
5. Tilt drawer on its back.
6. Remove three retaining screws in lower drawer trim. Remove loosened trim. Slide panel out. **HANDLE CAREFULLY SO THE PANELS WILL NOT BE SCRATCHED OR BENT.** Replace panel so desired color is exposed, making sure that handle trim bezel is placed into slots in panels.
7. Replace trim and screws.
8. Re-attach drawer to track and replace drawer retaining screws.



## Drawer Panels — Free Standing Unit:

1. **Disconnect power supply to compactor before changing panel.**
2. Tilt compactor toward rear. **DO NOT LAY UNIT ON ITS BACK OR DAMAGE TO CORD MAY RESULT.**
3. Remove three retaining screws in lower drawer trim. Remove loosened trim and slide panels out. **HANDLE CAREFULLY SO THE PANELS WILL NOT BE SCRATCHED OR BENT.** Replace panel so desired color is exposed, making sure that handle trim bezel is placed into slots in panels.
4. Replace trim and screws.

## Use Energy Wisely

A trash compactor uses a negligible amount of energy. Total energy requirements associated with the trash compactor will be minimized by following the recommendations in this Use and Care Guide.

ENERGY USAGE	KWH per month	Cost per month
2 cycles per day	1.01	\$0.08*

\*Based on average utility rate of \$0.08 per kilowatt hour.

## Availability of Accessories

Trash bags and charcoal air filters may be obtained from your KitchenAid dealer or direct from KitchenAid through the mail.



Decorator control panels are available through your KitchenAid dealer in either White or Almond to match kitchen decor.

## Conversion to a Free Standing Unit

Laminated Maple Wood Top Conversion Kit (Part #4164800) — A beautifully finished, 1-inch thick, maple wood top is available through your KitchenAid dealer. The height of the Compactor with wood top is adjustable from 35 $\frac{1}{8}$ -inches to 36 $\frac{3}{8}$ -inches.

## Custom Front Panels to Accent Kitchen Decor

The stainless steel trim will also accommodate a locally purchased wood front up to ¼-inch thick. For more instructions on installing a wood front, refer to the Installation Instructions.

# If You Need Service or Assistance

## Follow These Steps

1. If your compactor should fail to operate, check the following before calling your dealer. Save the cost of a service call; the following situations are not covered by the warranty:
  - Is a fuse blown or the circuit breaker open? On free standing units, is the cord plugged into a grounded outlet?
  - Is the Trash Drawer tightly closed? It is possible for a cycle to be incomplete when the drawer has not been firmly closed before turning the key to **START**. If this occurs, the unit will shut off, but the drawer cannot be pulled open. Close the drawer firmly and turn the key to **START**. The ram will return to the original "up" position.
2. If the problem is not due to one of the above items, first call your dealer or repair service he recommends.
  - All service should be handled locally by the dealer from whom you purchased the unit or an authorized KitchenAid servicer.
3. In the event you are unable to obtain the name of a local authorized KitchenAid servicer, call KitchenAid Customer Relations, **TOLL FREE: 800-422-1230**.
  - A Consumer Affairs representative can recommend a qualified service company in your area.

- If you must call or write, please provide: Model Number, Serial Number, Date of Purchase and a complete description of the problem. Write to:

Consumer Relations Department  
KitchenAid, Inc.  
P.O. Box 558  
St. Joseph, MI 49085-0558

4. If you are not satisfied with the action taken, contact the Major Appliance Consumer Action Panel (MACAP). MACAP is a group of independent consumer experts that voices consumer views at the highest levels of the major appliance industry. Contact them only when the dealer, authorized servicer or KitchenAid, Inc., have failed to resolve your problem.

Major Appliance Consumer  
Action Panel  
20 North Wacker Drive  
Chicago, IL 60606

MACAP will in turn inform us of your action.

# Compactor Warranty

LENGTH OF WARRANTY:	KITCHENAID WILL PAY FOR:	KITCHENAID WILL NOT PAY FOR:
<b>ONE YEAR FULL WARRANTY FROM DATE OF PURCHASE.</b>	Replacement parts and repair labor to correct defects in materials or workmanship. Service must be provided by an authorized KitchenAid servicing outlet.	A. Service calls to: <ol style="list-style-type: none"> <li>1. Correct the installation of the compactor.</li> <li>2. Instruct you how to use the compactor.</li> <li>3. Replace house fuses or correct house wiring.</li> </ol>
<b>FIVE YEAR LIMITED WARRANTY ONE YEAR FULL PLUS SECOND THROUGH FIFTH YEAR LIMITED FROM DATE OF PURCHASE.</b>	Replacement parts (repair labor costs not included) for the one-half horsepower motor if defective in materials or workmanship.	B. Repairs when compactor is used in other than normal home use. C. Damage resulting from accident, alteration, misuse, abuse, improper installation or installation not in accordance with local electrical codes. D. Any labor costs during the limited warranty. E. Replacement parts or repair labor costs for units operated outside the United States. F. Pickup and delivery. This product is designed to be repaired in the home.

**KITCHENAID, INC. DOES NOT ASSUME ANY RESPONSIBILITY FOR INCIDENTAL OR CONSEQUENTIAL DAMAGES.**

Some states do not allow the exclusion or limitation of incidental or consequential damages, so this exclusion or limitation may not apply to you.

This warranty gives you specific legal rights and you may also have other rights which vary from state to state.

KITCHENAID, INC.  
 ST. JOSEPH, MICHIGAN USA 49085